

Extractor Induction Hob

User manual

CC90H84JAD, CC90H84PAD

SAMSUNG

Contents

Using this manual 3

The following symbols are used in this User Manual:	3
Model name & serial number	3

Safety instructions 4

Instructions about the WEEE	5
-----------------------------	---

Installing the hob 6

Safety instructions for the installer	6
Tools you will need	6
Connecting to the power supply	6
Installing into the countertop	8
Components	8
Product dimension	9
Filter Material Assembly	10

Before you start 10

Cooking zones	10
Control panel	11
Induction heating	12
Safety shutoff	12
Residual heat indicator	12
Temperature detection	13
Cookware	13
Using the touch buttons	16
Operating noises	16
Initial cleaning	16
Open Source Announcement	17

SmartThings 17

Registering a Device in SmartThings	17
SmartThings Support Services	17
Troubleshooting	18

Operation 18

Switching the appliance on	18
Switching the appliance off	18

Selecting cooking zone and power level	18
Boost	19
Using the Flex zone (only for flex zone applied models)	19
Flex zone Plus (only for flex zone plus applied models)	20
Keep warm	20
Timer	21
Pause/Resume	21
Quick stop	21
Child safety lock	21
Wi-Fi on/off setting	22
Easy setup mobile app connection	22
Sound on/off	23
Display brightness	23
Method to Enter Brightness Setting Mode	24
Auto pan detection Add Feature	24
Using the hood	25
Hood Smart/Auto	26
Hood AfterRun	26
AfterRun function settings	27
Smart mode sensitivity setting (only CC90H84JAD)	28

Cleaning and Maintenance 28

Cleaning the hob	28
Light soiling	28
Stubborn soiling	29
Problem dirt	29
Cleaning and maintaining the hood	30
Cleaning the hood	30
Cleaning the Hood (Dishwasher)	31
Cleaning the Hood Cover	31
Replacing the Grease Filter	32
Replacing the Charcoal Filter	33

Troubleshooting and service 34

Troubleshooting	34
Information codes	35
Service	39

Technical specifications

Product Fiche compliant to commission delegated regulation (EU) No 65/2014	39
Additional Product Information compliant to commission regulation (EU) No 66/2014	40
Product Fiche compliant to commission delegated regulation (EU) No 65/2014	40
Technical data	40
Cooking zones	40
Product information	41

Appendix

41

Using this manual

Please take the time to read this owner's manual, paying particular attention to the safety information contained in the following section, before using your appliance. Keep this manual for future reference.

If transferring ownership of the appliance, please remember to pass the manual on to the new owner.

The following symbols are used in this User Manual:

WARNING

Hazards or unsafe practices that may result in **severe personal injury or death**.

CAUTION

Hazards or unsafe practices that may result in **minor personal injury or property damage**.

CAUTION

To reduce the risk of fire, explosion, electric shock, or personal injury when using your hob, follow these basic safety precaution.

NOTE

Useful tips, recommendations, or information that helps users manipulate the product.

Model name & serial number

Both the model name and the serial number are labeled underneath the hob base.

For later use, write down the information or attach the additional product label (located on the top of the product) onto the current page.

Model Name _____

Serial Number _____

Safety instructions

WARNING

Failure to follow the instructions may result in electric shock, injury, fire, breakdown or explosion.

1. This appliance is not intended for use by persons (including children) with reduced physical, sensory or mental capabilities, or lack of experience and knowledge, unless they have been given supervision or instruction concerning use of the appliance by a person responsible for their safety.
2. **(For Use in Europe)** This appliance can be used by children aged from 8 years and above and persons with reduced physical, sensory or mental capabilities or lack of experience and knowledge if they have been given supervision or instruction concerning use of the appliance in a safe way and understand the hazards involved. Children shall not play with the appliance. Cleaning and user maintenance shall not be performed by children without supervision.
3. Children should be supervised to ensure that they do not play with the appliance.
4. If the supply cord is damaged, it must be replaced by the manufacturer, its service agent or similarly qualified persons in order to avoid a hazard.
5. The means for disconnection must be incorporated in the fixed wiring in accordance with the wiring rules.
6. This Appliance should be allowed to disconnect from the supply after installation. The disconnection may be achieved by having the plug accessible or by incorporating a switch in the fixed wiring in accordance with the wiring rules.
7. **WARNING:** If the surface is cracked, switch off the appliance to avoid the possibility of electric shock.
8. **WARNING:** Accessible parts may become hot during use. Young children should be kept away.
9. If this appliance has cleaning function, during cleaning conditions the surfaces may get hotter than usual and children should be kept away.
10. A steam cleaner is not to be used.
11. After use, switch off the hob element by its control and do not rely on the pan detector.
12. The appliance must not be installed behind a decorative door in order to avoid overheating.
13. **(For Use in Europe) WARNING:** The appliance and its accessible parts become hot during use. Care should be taken to avoid touching heating elements. Children less than 8 years of age shall be kept away unless continuously supervised.

14. **(For Use in Europe) WARNING:** Unattended cooking on a hob with fat or oil can be dangerous and may result in fire. NEVER try to extinguish a fire with water, but switch off the appliance and then cover flame e.g. with a lid or a fire blanket.
15. **(For Use in Europe) CAUTION:** The cooking process has to be supervised. A short term cooking process has to be supervised continuously.
16. **WARNING:** Danger of fire: do not store items on the cooking surfaces.
17. **(For Use in Europe) WARNING:** Use only hob guards designed by the manufacturer of the cooking appliance or indicated by the manufacturer of the appliance in the instructions for use as suitable or hob guards incorporated in the appliance. The use of inappropriate guards can cause accidents.
18. **CAUTION:** The cooking process has to be supervised. A short term cooking process has to be supervised continuously.
19. **WARNING:** Unattended cooking on a hob with fat or oil can be dangerous and may result in fire.
20. There shall be adequate ventilation of the room when the range hood is used at the same time as appliances burning gas or other fuels (not applicable to appliances that only discharge the air back into the room).
21. There is a fire risk if cleaning is not carried out in accordance with the instructions.
22. **CAUTION:** This appliance is not intended to be used with gas hobs.
23. **CAUTION:** Accessible parts may become hot when used with cooking appliances.
24. **CAUTION:** Do not use the appliance with gas hobs.

WARNING: For proper connection to the power source, follow the wiring diagram attached near the terminals.

Connecting to the power source: Before connecting, check if the nominal voltage of the appliance – indicated on the technical data plate – matches the available power supply voltage. The technical data plate is located on the lower casing of the cooktop.

WARNING: Turn off the circuit power before connecting the cables to the circuit. The heating element voltage is 230 V AC.

The appliance also operates properly on AC 220 V~ or AC 240 V~ power supplies. The cooktop must be connected to the power supply using a device that allows disconnection of the appliance from the power supply at all poles, with contacts having a minimum width of 3 mm – for example, automatic line protection devices, grounding devices, fuses, or circuit breakers.

WARNING: Cable connections must be made in accordance with regulations, and the terminal screws must be tightly secured.

WARNING: After connecting the cooktop to the power supply, check if all cooking zones are ready for use, starting each zone one by one, at maximum setting, with suitable cooking vessels.

Any modifications or repairs must be performed by qualified personnel only.

Do not heat food or liquids sealed in containers for the induction function.

Do not use benzene, thinner, alcohol, or steam or high pressure cleaners to clean the induction.

Do not install the induction near a heater or flammable material, locations that are humid, oily, dusty or exposed to direct sunlight or water, or where gas may leak, or an uneven surface.

This induction must be properly grounded in accordance with local and national codes.

Regularly use a dry cloth to remove foreign substances from the power plug terminals and contacts.

Do not pull, excessively bend, or place heavy objects on the power cord.

Do not touch the power cord with wet hands.

While the induction is operating, do not turn it off by unplugging the power cord.

Do not insert fingers or foreign substances. If foreign substances are present in induction, unplug the power cord and contact a local Samsung service center.

Do not apply excessive pressure or impact to the induction. Do not place the cooktop over fragile objects.

Ensure the power voltage, frequency, and current matches the product specifications.

Firmly plug the power plug into the wall socket. Do not use multiple plug adapters, extension cords, or electric transformers.

Do not hook the power cord on metal objects. Make sure the cord is between objects or behind the induction.

Do not use a damaged power plug, power cord, or loose wall socket. For damaged power plugs or cords, contact a local Samsung service center.

Do not pour or directly spray water onto the induction, place objects on it, or use volatile materials such as insecticide.

Do not store flammable materials in the induction. Because alcohol vapours can contact hot parts of the induction, use caution when heating food or drinks containing alcohol.

If there is a risk of burning your hands on the top of the induction, keep children away and do not let them be near you.

The room must be properly ventilated when the cooker hood is used at the same time as combustion devices (e.g., a fireplace or gas appliance). For example, doors, windows, air intake/exhaust wall vents, or similar measures should be used to ensure adequate airflow and prevent the room from becoming sealed while the hood is in operation. When the cooker hood is used together with such devices, the negative pressure in the room must not exceed 4 Pa (4×10^{-5} bar). Otherwise, there is a risk that toxic combustion gases from the chimney could be drawn into the living space.

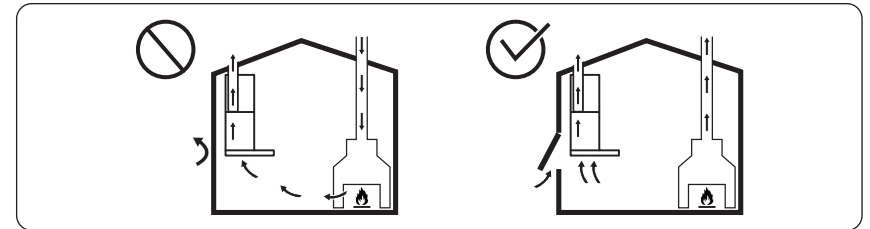

Instructions about the WEEE



Correct Disposal of This Product (Waste Electrical & Electronic Equipment) (Applicable in countries with separate collection systems)

This marking on the product, accessories or literature indicates that the product and its electronic accessories (e.g. charger, headset, USB cable) should not be disposed of with other household waste at the end of their working life. To prevent possible harm to the environment or human health from uncontrolled waste disposal, please separate these items from other types of waste and recycle them responsibly to promote the sustainable reuse of material resources.

Household users should contact either the retailer where they purchased this product, or their local government office, for details of where and how they can take these items for environmentally safe recycling.

Business users should contact their supplier and check the terms and conditions of the purchase contract. This product and its electronic accessories should not be mixed with other commercial wastes for disposal.

For information on Samsung's environmental commitments and product regulatory obligations, e.g. REACH, visit our sustainability page available via www.samsung.com

Installing the hob

▲ WARNING

Be sure the new appliance is installed and grounded only by qualified personnel. Please observe this instruction. The warranty will not cover any damage that may occur as a result of improper installation.

Technical data is provided at the end of this manual.

Safety instructions for the installer

- A device must be provided in the electrical installation that allows the appliance to be disconnected from the mains at all poles with a contact opening width of at least 3 mm. Suitable isolation devices include line protecting cut - outs, fuses (screw type fuses are to be removed from the holder), earth leakage trips and contactors.
- With respect to fire protection, this appliance corresponds to EN 60335 - 2 - 6. This type of appliance may be installed with a high cupboard or wall on one side.
- The installation must guarantee shock protection.
- The kitchen unit in which the appliance is fitted must satisfy the stability requirements of DIN 68930.
- For protection against moisture, all cut surfaces are to be sealed with a suitable sealant.
- On tiled work surfaces, the joints in the area where the hob sits must be completely filled with grout.
- On natural, artificial stone, or ceramic tops, the snap action springs must be bonded in place with a suitable artificial resin or mixed adhesive.
- Ensure that the seal is correctly seated against the work surface without any gaps. Additional silicon sealant must not be applied; this would make removal more difficult when servicing.
- The hob must be pressed out from below when removed.
- A board can be installed underneath the hob.
- The ventilation gap between the worktop and front of the unit underneath it must not be covered.

Tools you will need



Pencil



Phillips Head Screwdriver



Ruler or Straightedge



Safety Glasses



Saber Saw

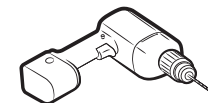

Drill

Connecting to the power supply

Before connecting, check that the nominal voltage of the appliance, that is, the voltage stated on the rating plate, corresponds to the available supply voltage. The rating plate is located on the lower casing of the hob.

▲ WARNING

Shut off power to circuit before connecting wires to circuit.

The heating element voltage is AC 230 V~. The appliance also works perfectly on networks with AC 220 V~ or AC 240 V~. The hob is to be connected to the mains using a device that allows the appliance to be disconnected from the mains at all poles with a contact opening width of at least 3 mm, eg. automatic line protecting cut - out, earth leakage trips or fuse.

▲ WARNING

The cable connections must be made in accordance with regulations and the terminal screws tightened securely.

▲ WARNING

Once the hob is connected to the mains supply, check that all cooking zones are ready for use by briefly switching each on in turn at the maximum setting with suitable cookware.

⚠ WARNING

Pay attention (conformity) to phase and neutral allocation of house connection and appliance (connection schemes); otherwise, components can be damaged.

Warranty does not cover damage resulting from improper installation.

⚠ WARNING

If the supply cord is damaged, it must be replaced by the manufacturer, its service agent or similarly qualified persons in order to avoid a hazard.

220-240V/380-415V 3N~

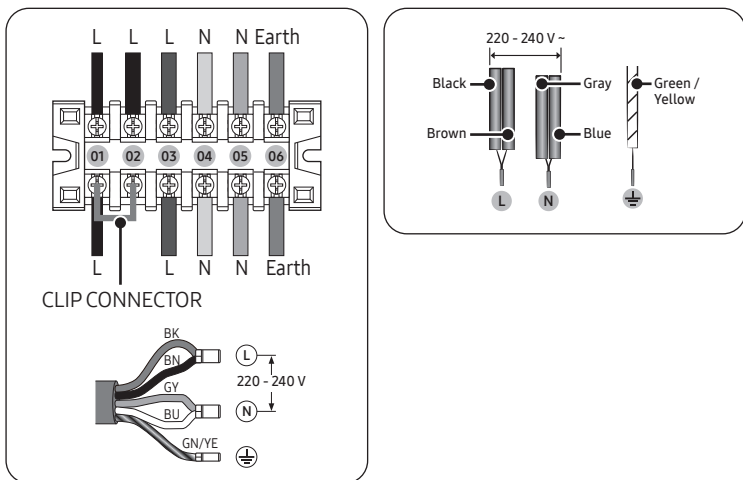

- If the CLIP CONNECTOR is not properly connected, the product may not function correctly.

⚠ WARNING

For correct supply connection, follow the wiring diagram attached near the terminals.

⚠ WARNING

Ensure you use the following torque specifications when connecting the power cord to the terminal block.

Torque: 15 ~ 20 kgf.

220-240V/380-415V 2N~

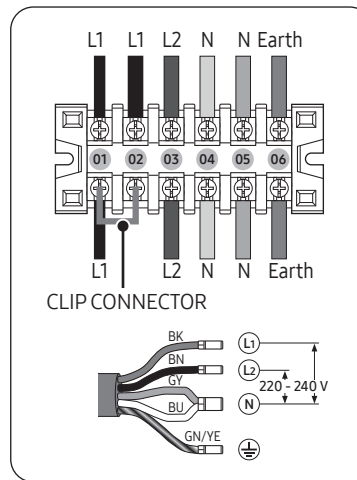

2N~ (16A): Separate the 2-phase wires (L1 and L2) before connection.

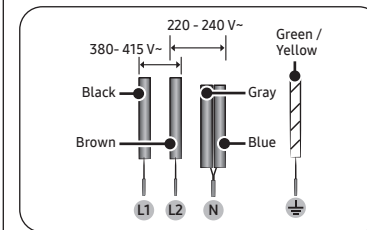

220-240V/380-415V 3N~

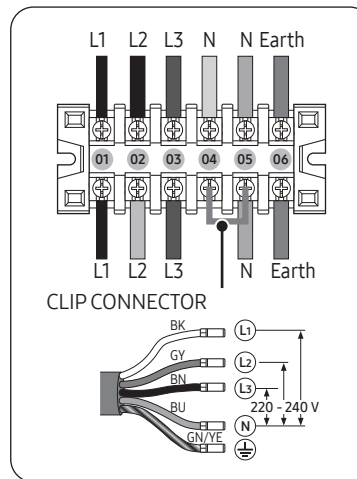

2 x 1N~ (16A): Separate the wires before connection.

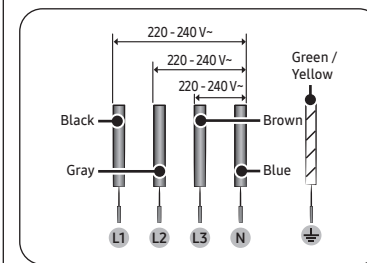

Installing the hob

Installing into the countertop

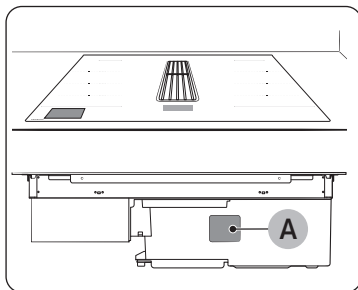

A. Serial number

NOTE

Make a note of the serial number on the appliance rating label prior to installation. This number will be required in the case of requests for service and is no longer accessible after installation. The original label is attached to the side of the hood.

NOTE

Pay special attention to the minimum space and clearance requirements.

NOTE

The bottom of the hob is equipped with a fan. If there is a drawer under the hob it should not be used to store small objects or paper, since they could damage the fan or interfere with the cooling if they are sucked into it.

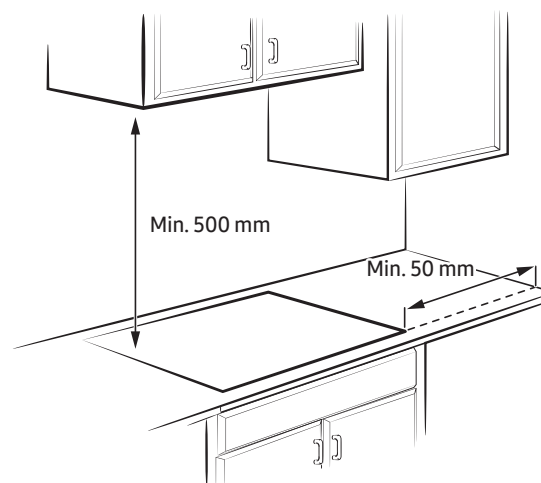

Components



Bracket Spring (6)

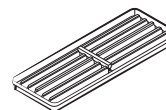

Grille

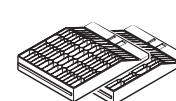

Charcoal Filter (2)

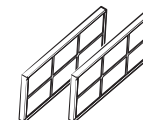

Grease Filter (2)

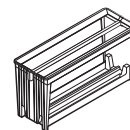

Tray Filter



Power Cord
(with Ferrite Core)

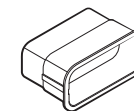

Assy Duct

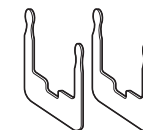

Clip Connector (2)

Product dimension

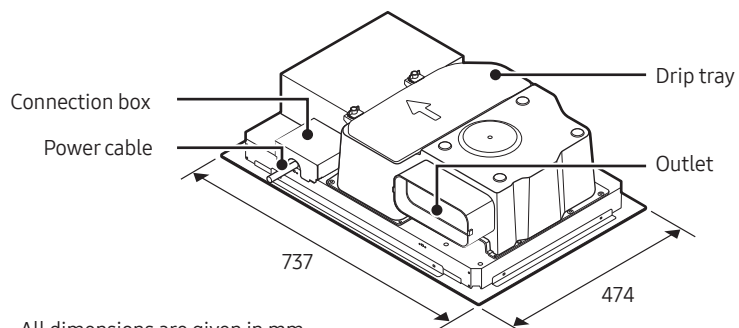
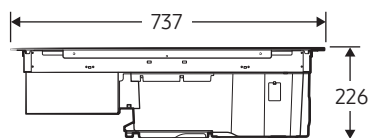
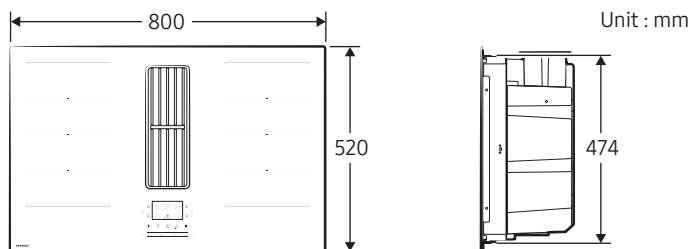

All dimensions are given in mm.

- Power cable length : 1,500 mm

NOTE

Foam tape is attached to the left side of the bottom of the glass to reduce impact and prevent breakage.

Cut-out size worktop

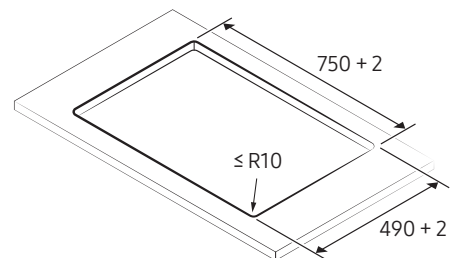

Air outlet dimension

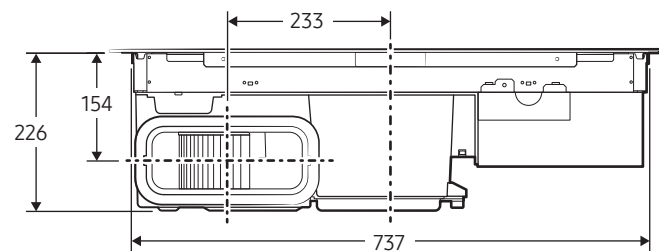

Installing the hob

Filter Material Assembly

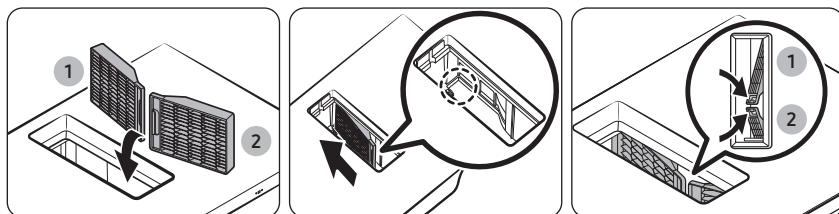

1. Place one charcoal filter into the fixed slot and press the top to lock it.
2. Place the other charcoal filter into the adjacent slot and press the top to lock it in place.

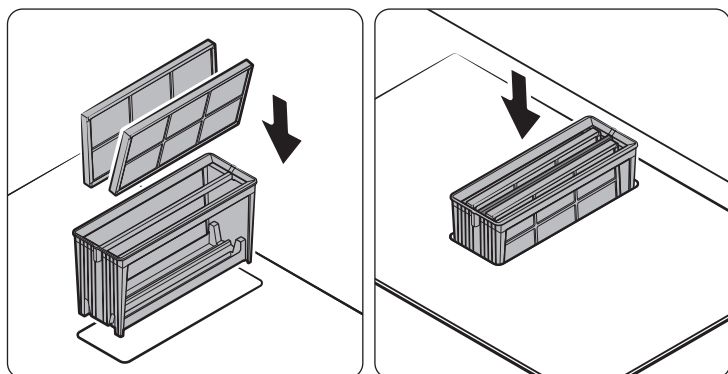

3. Insert Filter box(Tray filter + Grease filter) into the set.

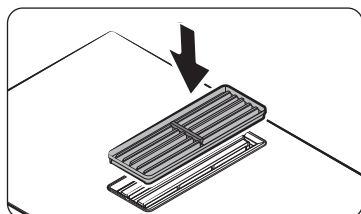

4. Put the Hood Grille on the set.

NOTE

- Disassembly : Remove the filters in reverse order of installation.
- Charcoal filter must be assembled in recirculation installation.

CAUTION

Please be careful not to drop the accessories (hood grille and filters) when installing or cleaning.

Before you start

Cooking zones

CC90H84JAD

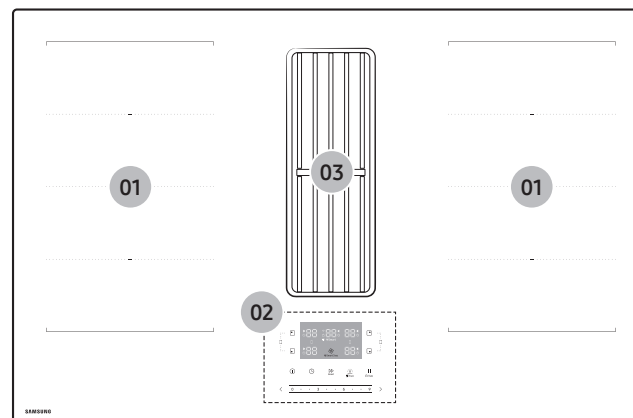

CC90H84PAD

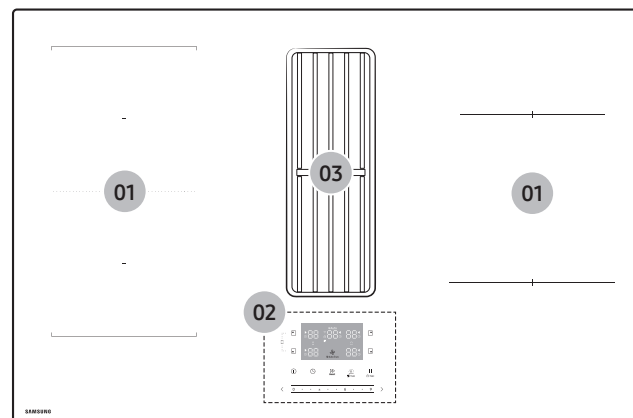

01	Induction cooking zone
02	Control panel
03	Hood Ventilation

Control panel

CC90H84JAD

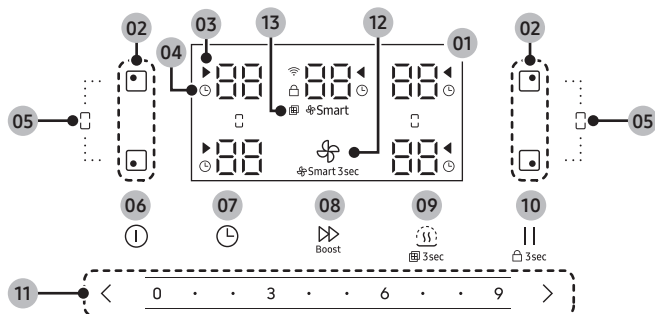

CC90H84PAD

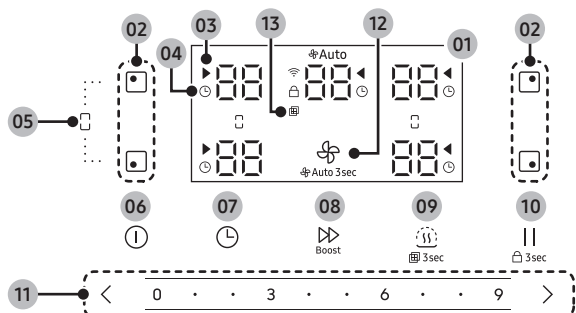

01	Screen	Shows the overall operating status of the product.
02	Cooking Zone Choose Button	Buttons for selecting each cooking zone.
03	Choose Cooking Zone Indicator	Lights up when a cooking zone is selected.
04	Timer Indication	The timer displays the selected cooking zone.
05	Flex Selection Button	Button for selecting the Flex Zone.
06	Power Button	You can turn the product off or on.

07	Safety cut-off timer Button	Set or cancel the cooking time.
08	Boost Button	Use the output of the fire pit for a certain period of time as a higher output.
09	Warm/Charcoal Filter Reset Button	Set the heat preservation function. You can keep the temperature of the stew constant. When the filter alarm occurs and need to reset the filter alarm is to press the Warm button for 3 seconds.
10	Pause / Lock Button	To switch all cooking zones on to the low power setting. Press 3 seconds to lock or unlock the control panel. (Child safety lock)
11	Output Control Button	The output of cooking zone and hood can be adjusted.
12	Hood Choose / Hood Smart/Auto Button	This is the button to select hood. Hood Smart/Auto mode can be operated to control the hood airflow according to the sensor and cooking zone power. <ul style="list-style-type: none"> Sensor and cooking zone power (CC90H84JAD) : Smart Cooking zone power (CC90H84PAD) : Auto
13	Charcoal Filter Replacement Alarm Indicator	The charcoal filter replacement alarm indicator turns on when the filter replacement cycle is reached, and the mobile notification is also activated. (Only for recirculation installation mode)

Before you start

Induction heating

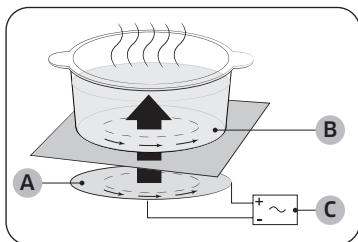

- A. Induction coil
- B. Induced currents
- C. Electronic circuits

- **The Principle of Induction Heating:** When you place your cookware on a cooking zone and you turn it on, the electronic circuits in your induction hob produce “induced currents” in the bottom of the cookware which instantly raise cookware’s temperature.
- **Greater speed in cooking and frying:** As the pan is heated directly and not the glass, the efficiency is greater than in other systems because no heat is lost. Most of the energy absorbed is transformed into heat.

Safety shutoff

If one of the cooking zones is not switched off or the power level is not adjusted after an extended period of time, that particular cooking zone will automatically switch itself off. The cooking zones switch themselves off at the following times.

Power level	Switch off
1 - 2	After 6 hours
3 - 6	After 5 hours
7 - 8	After 4 hours
9	After 1.5 hours

NOTE

If the Hob is overheated because of abnormal operation, will be displayed. And the Hob will be switched off.

NOTE

If cookware is unsuitable, too small, or no cookware has been placed on the cooking zone, will be displayed. And after 1 minute the corresponding cooking zone will be switched off.

NOTE

Should one or more of the cooking zones switch off before the indicated time has elapsed, see the “Troubleshooting”.

Other reasons why a cooking zone will switch itself off

All cooking zones will switch themselves off if liquid boils over on the control panel. The automatic shutoff will also be activated if you place a damp cloth on the control panel. In both of these instances, the appliance will need to be switched on again using the **Power** button after the liquid or the cloth has been removed.

Residual heat indicator

When an individual cooking zone or the hob is turned off, the presence of residual heat is shown with an (for “hot”) in the corresponding cooking zone display. Even after the cooking zone has been switched off, the residual heat indicator goes out only after the cooking zone has cooled.

You can use the residual heat for thawing or keeping food warm.

WARNING

As long as the residual heat indicator is illuminated, there is a risk of burns.

WARNING

If the power supply is interrupted, the symbol will go out and information about residual heat will no longer be available.

However, it may still be possible to burn yourself. This can be avoided by always taking care when near the hob.

Temperature detection

If for any reason the temperatures on any of the cooking zones were to exceed the safety levels, the cooking zone will automatically reduce to a lower power level.

When you have finished using the hob, the cooling fan will continue to run until the hob's electronics has cooled down. And the cooling fan switches itself off depending upon the temperature of the electronics.

Cookware

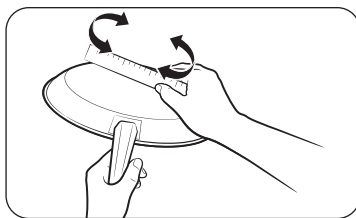

Use flat-bottomed cookware that completely contacts the entire cooking zone. Check for flatness by rotating a ruler across the bottom of the cookware. Be sure to follow all the recommendations for using cookware.

- Use cookware made with the correct material for induction cooking.
- Use quality cookware with heavier bottoms for better heat distribution. This gives best cooking results.
- Match the cookware size to the quantity of food being prepared.
- Do not let cookware boil dry. This may cause permanent damage in the form of breakage, fusion, or marring that can affect the ceramic hob. (This type of damage is not covered by your warranty).
- Do not use dirty cookware or cookware with heavy grease buildup. Always use cookware that is easy to clean after cooking.

⚠ CAUTION

- The cooking zones may appear cooled down after they have been turned off. However, the glass surface may be hot from residual heat transferred from the cookware. The risk of burns is still present.
- Do not touch hot cookware directly with your hands. Always use oven mitts or pot holders to protect your hands from burns.
- Do not slide cookware across the hob surface. Doing so may permanently damage the hob.

Cookware for induction cooking zones

The Induction cooking zone can only be turned on when cookware with a magnetic base is placed on one of the cooking zones. You can use the cookware identified as suitable below.

Material	Suitability
Steel, enameled steel, cast iron	Yes
Stainless steel	Yes (If magnet sticks to the bottom of the cookware)
Aluminum, copper, brass, glass, ceramic, porcelain	No

📖 NOTE

- Cookware appropriate for induction cooking is labelled as suitable by the manufacturer.
- Certain cookware can make noises when being used on induction cooking zones.
- These noises do not indicate that the hob is malfunctioning and do not affect its operation in any way.
- Special stainless-steel cookware may not be suitable for induction cooking. Check if the base of the cookware is attracted by a magnet.

Cookware sizes for induction cooking zones

Induction cooking zones adapt automatically to the bottom size of the cookware up to a certain limit. However, the magnetic part of the bottom of the cookware must have a minimum diameter depending upon the size of the cooking zone.

For best results, use cookware whose ferromagnetic diameter match that of a cooking zone. If the cookware is not sensed by the cooking zone, try a smaller sized cooking zone.

📖 NOTE

For Cookware diameter, please refer to the model's Cooking zones specifications.

Before you start

Other induction cookware

Some cookware has thin magnetic material on the bottom to work with an induction heating hob. These cookware has weak magnetism and may not work well. (Weak magnetism means a magnet does not stick firmly or the area where the magnet sticks is small.)

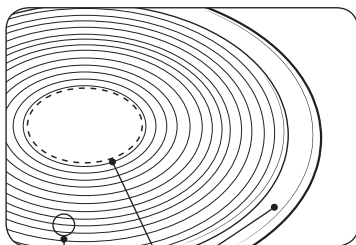

Even though cookware are designed for an induction hob, the heating performance could be weak or sometimes the hob may not detect the cookware depending on the size and strength of the magnetic area on the bottom of the cookware.

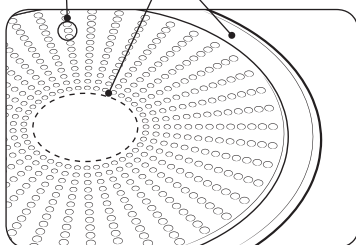

- A. Area where magnet does not stick
- B. Area where magnet sticks

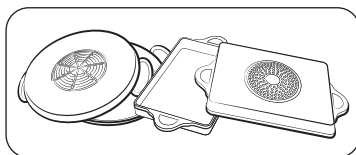

When using large cookware with a smaller ferromagnetic element, only the ferromagnetic element heats up. Consequently, heat might not be uniformly distributed.

Suitability test

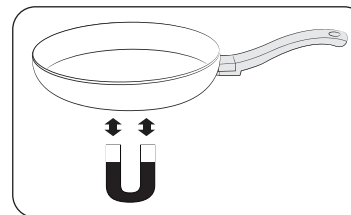

Cookware is suitable for induction cooking if a magnet sticks to the bottom of the cookware and the cookware is labelled as suitable by the cookware manufacturer.

- You can recognise good cookware by their bases. The base is supposed to be as thick and flat as possible.
- When buying new cookware, pay special attention to the diameter of the base. Manufacturers often give only the diameter of the upper rim.
- Do not use cookware which have damaged bases with rough edges or burrs. Damaged cookware can scratch the ceramic hob permanently if you slide them across the surface.
- When cold, cookware bases are normally bowed slightly inwards (concave). They must not be bent outwards (convex).
- If you want to use a special type of cookware, for example, a pressure cooker, a simmering pan, or a wok, please follow the manufacturer's instructions.

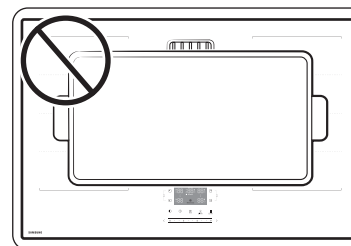

⚠ WARNING

Do not use both cooking zones on the left and right sides of a single cookware..

Recommendations for hood ventilation performance.

Tip : When using a pot with a height of 15 cm or more, direct the steam towards the hood ventilation using the pot lid and utensils for effective suction.

- We recommend using low-height pots to improve hood suction efficiency.

⚠ WARNING

- You must definitely use utensils that are resistant to high temperature.
- Be careful of burns and definitely wear gloves as the utensils are hot.

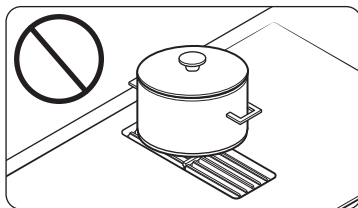
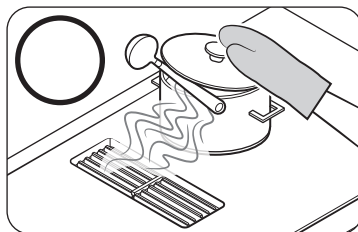
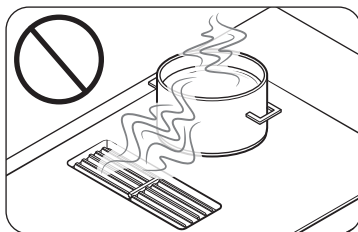

⚠ WARNING

- Do not block the hood Ventilation(Grille) with a pot.
- Do not place a hot pot on the hood Ventilation(Grille).
- Please be careful to prevent thin and lightweight objects(ex. Paper Towel) from being sucked into the Hood Ventilation(Grille).
- If even a small amount of foreign substances are present in the Hood Ventilation it can reduce the hood performance and increase noise during operation.

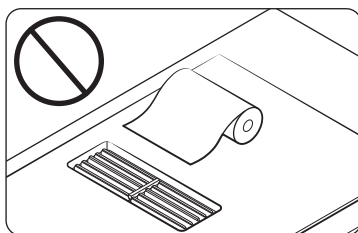

⚠ CAUTION

- This product may produce relatively loud noise when operating in boost mode due to its powerful hood function.
- When air passes through the charcoal filter designed for air purification, a whistling sound may occur during the airtight filtering.

Correct positioning

Correct	Incorrect
Flat-bottomed cookware and straight sides	Cookware with curved or warped bottoms or sides
The cookware meets or exceeds the recommended minimum size for the cooking zone.	The cookware does not meet the minimum size required for the current cooking zone.
The cookware rests completely on the hob surface.	The cookware rests on the hob trim or does not rest completely on the hob surface.
The cookware is properly balanced.	The heavy handle causes the cookware to tilt.

Before you start

Energy saving tips

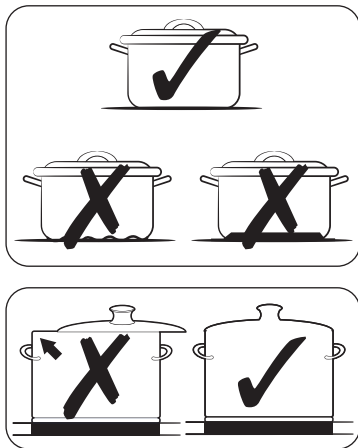





Follow these tips to save power consumption.

- Always put cookware on a cooking zone before you turn the corresponding burner on.
- Keep the cooking zones and cookware bases clean. Otherwise, more power will be consumed.
- Firmly close the cover of cookware if available. This will reduce power consumption.
- Turn the working burner off before the end of the cooking time. Use the residual heat to keep food warm.

Correct positioning

You can test cookware to see if they are suitable for use with the product.

1. Press the **Power**  button for 1-2 seconds to turn on the hob.
2. Press the **Pause & Lock**  button for 3 seconds to activate the child safety lock.
3. Press the **Timer**  button for 3 seconds to activate the cookware suitability test mode.
4. Place the cookware on the one of the cooking zones, and then press and hold the **Cooking zone**  button for 3 seconds.

Display	container fit index		Description
0	0 %	Unusable	Cookware is unsuitable
1 ~ 7	10 % ~ 70 %	Low efficiency	Cookware is suitable, but inefficient
8 ~ 10	80 % ~ 100 %	High efficiency	Cookware is suitable

Using the touch buttons

To operate the touch buttons, touch the desired button with the tip of your pointed finger until the relevant displays illuminate or go out, or until the desired function is activated. Ensure that you are touching only one button when operating the appliance. If your finger is too flat on the button, an adjacent button may be actuated as well.

Operating noises

If you can hear.

- **Cracking noise:** cookware is made of different materials.
- **Whistling:** you use more than two cooking zones and the cookware is made of different materials.
- **Humming:** you use high power levels.
- **Clicking:** electric switching occurs.
- **Hissing, Buzzing:** the fan operates.

The noise are normal and do not refer to any defects.

WARNING

Do not use cookware of different size and material.

Using cookware of different sizes or materials may cause noises and vibrations.

NOTE

Using low power levels (1 - 5) may cause clicking noises.

CAUTION

Hood vibration

- Hood vibration and Noise may occur depending on the installation environment and airflow of the product.

Initial cleaning

Wipe the ceramic glass surface with a damp cloth and ceramic hob glass cleaner.

WARNING

Do not use caustic or abrasive cleaners. The surface could be damaged.

Open Source Announcement

The software included in this product contains open source software.
The following URL http://opensource.samsung.com/opensource/SMART_TP1_0/seq/0 leads to open source license information as related to this product.



Security updates information

Security updates are provided to strengthen the security of your device and protect your personal information. For more information on security updates, visit <https://security.samsungda.com>.
* The website supports only some languages.

SmartThings

Scan the QR code on the front upper right surface of the product (location may vary by model) and follow the app's onscreen instructions to add your device.
See the specifications below for details.

Registering a Device in SmartThings

1. Install the App
 - Visit the Google Play Store or Apple App Store and search for "SmartThings."
 - Download and install the Samsung SmartThings app on your mobile device.
2. Sign in with a Samsung Account
 - A Samsung account is required to use the app. If you don't have a Samsung account, follow the app's instructions to create one.
 - Samsung smartphone users who register a Samsung account in their phone settings are automatically signed in.
3. Add a Device
 - Turn on the device you want to connect.
 - If the product has a QR code, you can also add the device by scanning it with your camera app.
 - Or, when you open the SmartThings app, a pop-up may appear saying that a new device has been found. Select Add.
 - If the device is not added using the methods above, tap Add Device in the SmartThings app, and follow the onscreen instructions to add the device.

NOTE

For the mobile requirements of the SmartThings app, please refer to the app information.

SmartThings Support Services

To learn how to use SmartThings with the device, tap the device card in the SmartThings app.
You can:

- Check and manage device status
- Set up automation routines
- Monitor energy usage

NOTE

SmartThings features available for your device may vary depending on model and app version.

SmartThings

Troubleshooting

When the connected device is not working,

- check the device status in the SmartThings app.
If Offline is displayed on the device card, the network connection has been lost.
- Close and restart the SmartThings app.
- Restart the router.
- Remove the device from the SmartThings app and add it again.
- If the problem persists, contact support via Error Reports.

Offline Device Diagnosis

- Run Offline Device Diagnosis in the SmartThings app.
- This feature can help identify the cause of the problem and resolve the issue.

NOTE

Wireless Network Specifications



- It is recommended to set the wireless router security type to WPA2 and the data encryption method to AES.
- IEEE 802.11 b/g/n (2.4 GHz) is recommended for wireless connections.

NOTE

- Wireless network connection quality may be affected by the router and the surrounding environment.
- If firewall settings or MAC address registration is required, please contact your internet service provider.

Operation



Switching the appliance on

The appliance is switched on using the **Power**  button. Press the **Power**  button for approximately 1 - 2 seconds.





NOTE

After the **Power**  button has been actuated to switch on your appliance, a power level must be selected within approximately 20 seconds. Otherwise, the appliance will switch itself off for safety reasons.

Switching the appliance off

To completely switch off the appliance, use the **Power**  button. Press the **Power**  button for approximately 1 - 2 seconds.

NOTE

After switching off a single cooking zone or the entire cooking surface, the presence of residual heat will be indicated in the digital displays of the corresponding cooking zones in the form of an  H  h two steps for "hot". The temperature is lowered,  H  h will be disappeared.

Selecting cooking zone and power level

1. For selecting the cooking zone, press the corresponding **Cooking zone**  button.
2. For setting and adjusting the power level, use the Control bar or Control key or Control knob.

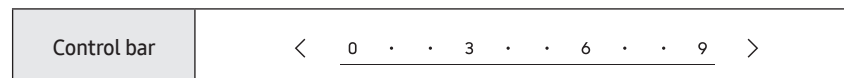

NOTE

- The default level is set to 0 when selecting the cooking zone.
- If more than one key is pressed for longer than 8 seconds,  will show in the cooking zone display.

Suggested settings for cooking specific foods

The numbers in the table below are guidelines. The power level required for various cooking methods depend on a number of variables, including the quality of the cookware being used and the type and amount of food being cooked.

Power level	Cooking method	Examples for Use
9	Warming / Sautéing / Frying	Warming large amounts of liquid, boiling noodles, searing meat, browning goulash, braising meat
7-8	Intensive frying	Steak, sirloin, hash browns, sausages
6-7	Frying	Schnitzel / chops, liver, fish, rissoles, fried eggs, pancakes / griddle cakes
4-5	Boiling	Cooking up to 1.5 l liquid, potatoes, vegetables
2-3	Steaming / Stewing / Boiling	Steaming and stewing of small amounts of vegetables, boiling rice and milk dishes
1	Melting	Melting butter, dissolving gelatine, melting chocolate

NOTE

You will need to adjust the power level according to specific cookware and foods.

Boost

The **Boost** function makes additional power available to the each cooking zones.
(example : bring a large volume of water to the boil)

After **Boost** times, the cooking zones automatically sets back to the highest heat setting.

NOTE

- In certain circumstances, the **Boost** function may be deactivated automatically to protect the internal electronic components of the hob.
For example, It is impossible to output max power on Flex zone rear and Flex zone front at the same time.
- Refer to your model's Cooking zones specification for **Boost** time.

Power management

The cooking zones have a maximum power available to them.

If this power range is exceeded by switching on the **Boost** function, Power Management automatically reduces the power level of cooking zone.

The display for this cooking zone alternates for some seconds between the set power level and the maximum possible power level. After then, the display changes from the set power level to maximum possible power level.

Using the Flex zone (only for flex zone applied models)

The Flex function can operate complete left side cooking zone for using large size cookware. (example : oval cookware, fish kettle)

1. Press the **Flex zone**  button.
2. For setting and adjusting the power level, use the **Power level** button.

NOTE

- Press the **Flex zone**  button during operating, **Flex zone** function will be off.
- If you press the Flex selection button, it starts from 0 regardless of whether it was previously operating with different firepower levels.

Operation

Flex zone Plus (only for flex zone plus applied models)

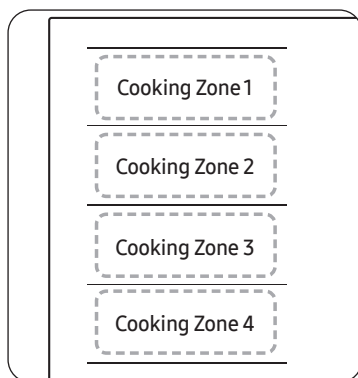

The Flex zone is the large cooking area located on the left side of the hob (see the figure left) that is specially designed to accommodate multiple pots and pans of varying shapes and sizes at once. The Flex zone has four zones that are operated by individual inductors, allowing you to cook regardless of where cookware is placed on a cooking zone.

With Flex zone Plus, you can use a combination of different cooking zones to enlarge the cooking area. Press the **Flex zone**  button to use the cooking zone as follows.

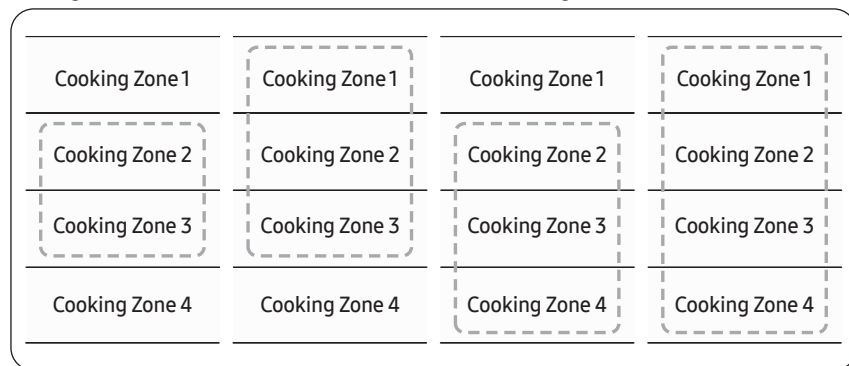



NOTE

- When using only one cooking zone, the diameter of the bottom of the cookware must be less than 18 cm.
- The hob may take 5 - 10 seconds to recognise the position of cookware.
- Noises may occur while the hob recognises the cookware.
- Do not remove cookware during cooking. For safety purposes, the hob automatically stops if cookware has been removed for more than 5 seconds.



Using the Flex zone Plus (Only for Flex zone plus applied models)

1. Press the **Flex zone**  button.
2. For setting and adjusting the power level, use the **Power level** button.

NOTE

- If you press the **Flex zone**  button during operating, **Flex zone** function will be off.
- If you press the **Flex zone**  button while each cooking zone is operating at different levels, it will be automatically adjusted to higher level.
- When moving or adding cookware to a new Flex zone, cancel the current operation, and then press the corresponding **Cooking zone**  button to activate the cooking zone.

Keep warm

1. Use this function to keep cooked food warm. Press the corresponding **Cooking zone**  button.
2. Press the **Keep warm**  button.
3. The cooking zone display will be changed.
4. Press the **Keep warm**  button again to turn off the cooking zone.



Timer

Using the timer as a safety shutoff

If a specific time is set for a cooking zone, the cooking zone will shut itself off once this period of time has elapsed. This function can be used for multiple cooking zones simultaneously.

Setting the timer

The cooking zone(s) for which you want to apply the safety shutoff must be switched on.



1. Press the **Timer**  button.
2. Set timer by repeatedly pressing the **Timer**  button.
3. To cancel the timer settings, hold the **Timer**  button for 2 seconds.

NOTE



- To change the settings quicker, press and hold any of the **Timer**  button until the desired value is reached.
- When the timer is terminated, it sounds a beep.

Pause/Resume

The **Pause/Resume** function simultaneously switches all cooking zones that are switched on to the low power setting and then back to the power level that was previously set. This function can be used to briefly interrupt and then continue the cooking process e.g. to take a telephone call.

When the **Pause/Resume** function is activated, all keys except for the **Pause & Lock**  and the **Power**  buttons are disabled.

To resume cooking, press the **Pause & Lock**  button again.

	Control Panel	Display
To Switch On	Press the Pause & Lock  button	
To Switch Off	Press the Pause & Lock  button	Return to previous power level

Quick stop

This option reduces the step and time it takes to stop cooking.

To switch off a cooking zone, press the **Cooking zone**  button for 2 seconds.



NOTE

The **Flex zone**  button does not support quick stop function.



Child safety lock

You can use the child safety lock to safeguard against unintentionally turning on a cooking zone and activating the cooking surface. Also the control panel, with the exception of the **Power**  button (Only turn off control), can be locked in order to prevent the settings from being changed unintentionally, for example, by wiping over the panel with a cloth.

Switching the child safety lock On/Off

1. Press the **Pause & Lock**  button for approximately 3 seconds. An acoustic signal will sound as confirmation.
2. Press any button.  will appear in the displays, indicating the child safety lock has been activated.
3. For switching the child safety lock off, press the **Pause & Lock**  button again for 3 seconds. An acoustic signal will sound as confirmation.

NOTE

- Regardless of power on/off, child lock is activated.
- You can set the child safety lock during cooking. To turn off the cooking zone with the child safety lock on, press the **Power**  button or turn off the child safety lock first and then press the corresponding **Cooking zone**  button.

Operation

Wi-Fi on/off setting

Use for turning Wi-Fi on/off.



1. Please press and hold the **Power** button (for more than 1 second) to turn on the product.



2. Press and hold the **Pause & Lock** button to set the lock, and press and hold the **Boost** button (for more than 3 seconds).

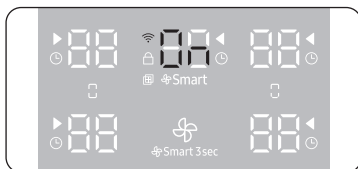

Easy setup mobile app connection

Search for 'SmartThings' on the Google Play Store, Galaxy Store, or Apple App Store. Download and install the SmartThings app provided by Samsung Electronics on your smart device. A Samsung account is required to use the app.

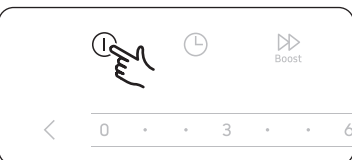

1. Press and hold the **Power** button for more than 1 second to turn on the product, and prepare your mobile app (SmartThings).

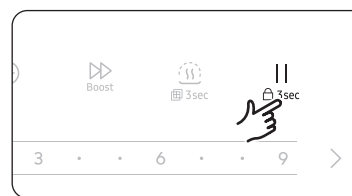

2. Press and hold the **Pause & Lock** button for about 5 seconds. When the AP message appears, prepare to connect with the mobile app. Follow the guide displayed on the mobile app to proceed with the connection.
 - Even after the 'L' appears, please keep pressing it.

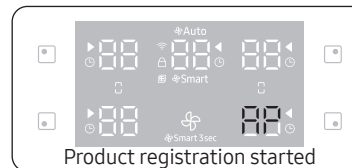

3. When starting product registration, 'AP' is displayed.

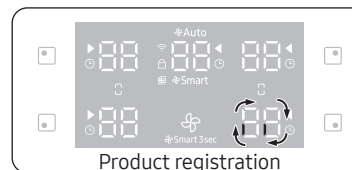

4. While the device registration is in progress, it is shown as illustrated.

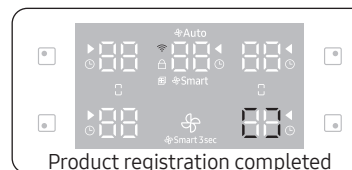

5. When the product registration is complete, it is displayed as shown in the illustration and blinks for 3 seconds.
6. Monitor registered products.

NOTE

The design of the cooking zone and control panel may vary depending on the model.

Sound on/off

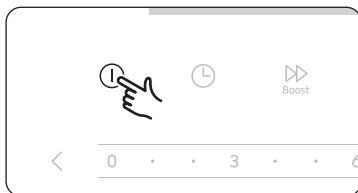

1. Press the **Power** (⏻) button for approximately 1 - 2 seconds.

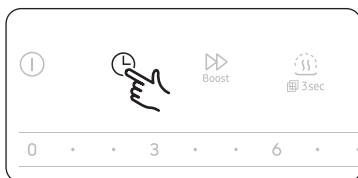

2. Press the **Timer** (⌚) button for 2 seconds within 10 seconds after the power has turned on.

NOTE

- Sound will turn off and **OFF** will be displayed in the display.
- To change the sound setting, repeat steps 1 and 2. Sound will turn on and **ON** will be displayed in the display.
- It is not possible to change the sound settings after 10 seconds from turning the power on.

Display brightness



1. Check if the power is turned off.



2. Press and hold the **Pause & Lock** (||) button to set the lock.



3. Please press the **Timer** (⌚) button for 3 seconds.

Operation

Method to Enter Brightness Setting Mode

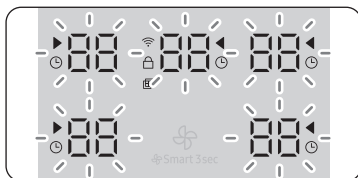

1. When selecting the screen brightness setting mode, all screens blink.

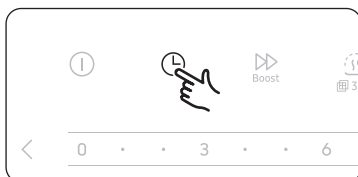

2. Press the **Timer** button to adjust the brightness.
 - Press the **Timer** button briefly and enter the brightness setting stage.

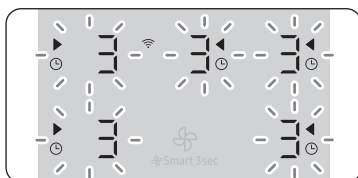

3. The icon blinks along with the current brightness. Each time the **Timer** button is pressed, the brightness changes in the order: 3 → 4 → 5 → 1 → 2.

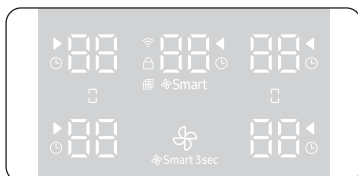

4. After about 3 seconds, the setting is completed and the lock is automatically released.

NOTE

Do not press the **Power** button after entering the brightness setting mode.

Auto pan detection Add Feature



1. Check if the power is turned off.



2. Press and hold the **Pause & Lock** button for more than 3 seconds to set the lock.

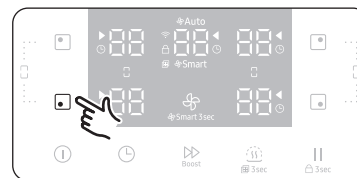

3. While in the locked state, press and hold the **LF cooking zone** button for more than 3 seconds.

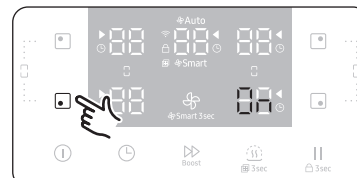

4. You can turn the function on or off using the **LF cooking zone** button.

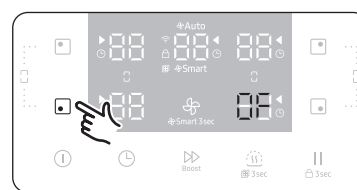



NOTE

The automatic pan detection function is OFF by default. However, the setting is only available when all cooking zones are turned off.

Using the hood

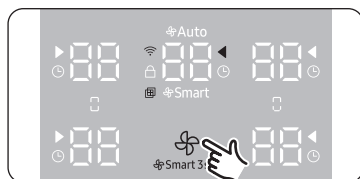
Manual Operation



1. Press and hold the **Hood**  button.

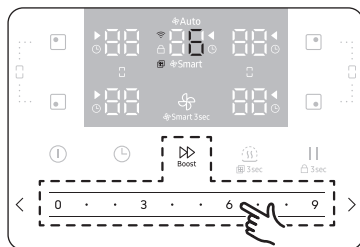

2. Press **0~9** or **Boost**  and then hood will be operated.

NOTE

Operate the Boost mode for 8 minutes and then change to 9 Level.

- Boost mode Display

00 > 00 > 00 > 00 > 00 > 00

Smart/Auto Operation

(CC90H84JAD) Smart : This function is that automatically adjusts the airflow when the sensor and cooking zone power detects harmful gases generated during cooking.

(CC90H84PAD) Auto : This function is that automatically adjusts the airflow according to the cooking zone power.

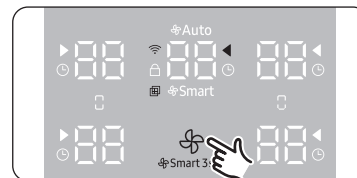

Press and hold the **Hood**  button for 3 seconds to select options.

NOTE

Smart/Auto operation Default : On

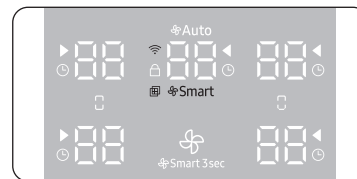

NOTE

- If the option is turned on while in manual mode inactive or AfterRun inactive state, the indicator will turn on.
- While in manual mode, regardless of previously set options, pressing and holding the hood will turn on the indicator and activate Smart/Auto operation.
- While Smart/Auto is operating, pressing and holding the hood will terminate Smart/Auto operation.
- If Smart/Auto is terminated by pressing for 3 seconds and then the power is turned off and on again, Smart/Auto operation will not start.
- If Smart/Auto is activated by pressing for 3 seconds and then the power is turned off and on again, Smart/Auto operation will start.
- You can operate the hood manually after the Smart/Auto mode is turned off.
- If a lot of smoke (steam) occurs during cooking and the suction in Smart/Auto mode is insufficient, please switch to manual operation.
- Smart/Auto mode Display

00 > 00 > 00 > 00 > 00 > 00 > 00 > 00

Operation

Hood Smart/Auto

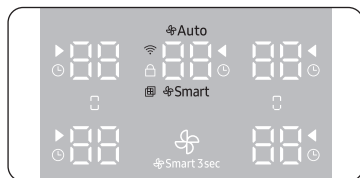

This is an explanation of the Smart/Auto automatic start.

- If you previously turned on the Smart/Auto mode, the device will automatically start in Smart/Auto when you turn it off and then on again.
- If you previously turned on the Smart/Auto mode, under conditions where the hood is not manually operating (1~9, boost), if the cooking zones are completely turned off and then at least one cooking zone starts operating, the Smart/Auto will automatically start.

NOTE

- If the Smart/Auto feature was previously turned on, the Smart/Auto indicator will light up immediately when you turn on the power.
- When the cooking zone is not operating, the hood fan will not operate according to the automatic mode. (However, the Smart/Auto indicator remains lit.)
- If there is no cooking zone operation for 20 seconds, the set power will turn off.
- When the cooking zone is operating, the hood fan will operate according to the automatic mode.
- When using pots as high height, the hood suction effective may be reduced.

Hood AfterRun

This function is that operates the hood for a certain period of time after stopping to dry out the moisture inside the product.

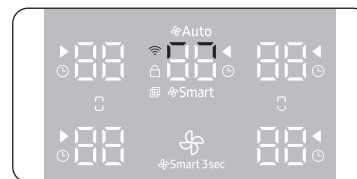

- Operation when the hood is turned off while it is running.
- AfterRun operation when the hood timer is set and the cooking is finished, at the end of the timer.
- AfterRun operation only when the hood has been running for more than 1 minute and then turned off. (based on hood fan operation)
- When the device is turned off with the **Power** (ⓘ) button, the AfterRun operation occurs, and when the **Power** (ⓘ) is turned off again, the AfterRun ends.
- When the hood is turned off, AfterRun operates and then you can select the hood to change fan speed.
- AfterRun operates due to the timer ending during manual hood operation.
- Even if the **Power** (ⓘ) is turned off during AfterRun operation, AfterRun is maintained.

CAUTION

- Do not place containers on the hood.
- Please refrain from using the hood to lower the temperature of hot containers.
- If an odor occurs, please ventilate immediately or turn on the hood.

NOTE

Hood AfterRun Operation Indicator



AfterRun function settings

This function is that operates the hood for a certain period of time after stopping to dry out the moisture inside the product.



1. Check if the **Power**  is turned on.



2. Press and hold the **Pause/Lock**  button for 3 seconds to set the lock.

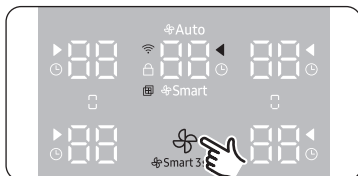

3. Press and hold the **Hood**  button for 3 seconds to set the AfterRun feature.

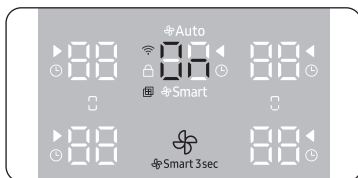

NOTE

- Default : On
- It can only be set when both the hood and cooking zone are not operating.

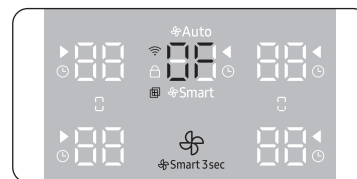

NOTE

- If you need to change the AfterRun hood wind speed and ventilation time settings through the SmartThings App.
- AfterRun operation works according to before setting hood wind speed, and If you set the wind speed number high, it operates quickly.
 - Wind speed: 1(default) / 2 / 3
 - Ventilation time: 5 minutes / 10 minutes / 15 minutes / 20 minutes(default) / 25 minutes

Operation

Smart mode sensitivity setting (only CC90H84JAD)

This function is that allows to set the sensor sensitivity when operating in Smart mode.



1. Sensitivity settings are available when the power is on and press the **Power** button for 1 second.
 - It can only be set when the hood is not working.

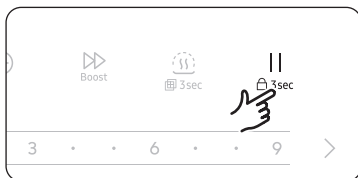

2. Press and hold the **Pause/Lock** button for 3 seconds to set the lock.

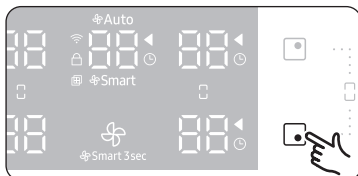

3. Press and hold the **RF cooking zone** button for 3 seconds to enter.
4. Check and change the current sensitivity setting.

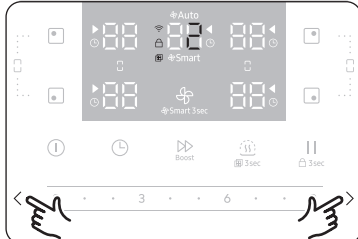

- NOTE**
- Change the setting value using the <> buttons.
 - Sensitivity has a total of 3 levels (Low/Medium(default)/High). (Low: 1, Medium: 2, High: 3)
 - The setting is automatically applied and maintained after 3 seconds.

Cleaning and Maintenance

Cleaning the hob

⚠ WARNING

Cleaning agents must not come into contact with a heated ceramic glass surface: All cleaning agents must be removed with adequate amounts of clean water after cleaning because they can have a caustic effect when the surface becomes hot. Do not use any aggressive cleaners such as grill or oven sprays, scouring pads or abrasive pan cleaners.

📖 NOTE

Clean the ceramic glass surface after each use when it is still warm to the touch. This will prevent spillage from becoming burnt onto the surface. Remove scales, watermarks, fat drippings and metallic discolouration with the use of a commercially available ceramic glass or stainless steel cleaner.

Light soiling

1. Wipe the ceramic glass surface with a damp cloth.
2. Rub dry with a clean cloth. Remnants of cleaning agent must not be left on the surface.
3. Thoroughly clean the entire ceramic glass cooking surface once a week with a commercially available ceramic glass or stainless steel cleaner.
4. Wipe the ceramic glass surface using adequate amounts of clean water and rub dry with a clean lint - free cloth.

Stubborn soiling

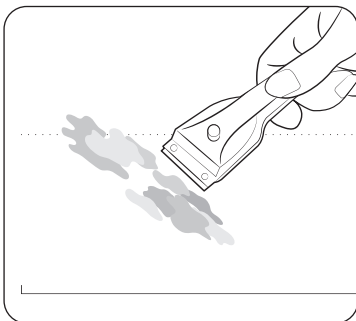

1. To remove food that has boiled over and stubborn splashes, use a glass scraper.
2. Place the glass scraper at an angle to the ceramic glass surface.
3. Remove soiling by scraping with the blade.
4. Remove burnt sugar, melted plastic, aluminum foil, or any other material with a glass scraper as quickly as possible. Work when it is still hot.

NOTE

Glass scrapers and ceramic glass cleaners are available from specialty retailers.

CAUTION

The use of glass scrapers in hot cooking areas risks getting burned.

Problem dirt

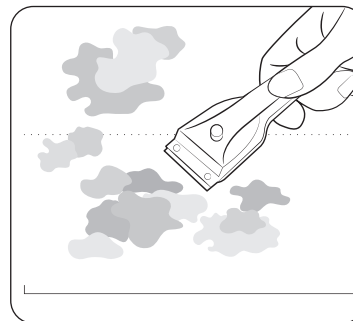

1. Remove burnt-on sugar, melted plastic, aluminium foil or other materials with a glass scraper immediately and while still hot.

WARNING

There is a risk of burning yourself when the glass scraper is used on a hot cooking zone:

2. Clean the hob as normal when it has cooled down. If the cooking zone on which something has melted has been allowed to cool, warm it up again for cleaning.

NOTE

Scratches or dark blemishes on the ceramic glass surface, caused, for example, by a pan with sharp edges, cannot be removed. However, they do not impair the function of the hob.

WARNING

- After cooling down, clean the cooktop normally. If the cooking area where something has melted has already cooled down, heat it again to clean.
- For example, scratches or black stains on the surface of ceramic glass due to pots with sharp edges cannot be removed.
- However, these things do not interfere with the normal operation of the cooktop.
- Do not use vinegar, lemon juice or other stain removers on the cooktop frame. There is a risk of permanent stains.
- Wipe the frame with a damp cloth.
- Moisten the dry residue with a damp cloth and wipe until it dries completely.
- Do not use the cooktop as a workbench or storage space to prevent damage to the device.
- Do not place pots in the cooking area or use empty pots.
- Ceramic glass is very resistant to temperature changes, but it is easy to break. Sharp or hard objects can easily damage it upon impact.
- Do not place the pot on the cooktop frame. There is a risk of scratches and finish damage.

Cleaning and Maintenance

- Be careful not to spill acidic liquids such as vinegar, lemon juice or limestone into the cooktop frame. These liquids can cause persistent stains.
- When food containing sugar melts in contact with hot cooking surfaces, it must be cleaned with scrapers immediately while still warm. If the residue cools, there is a risk of surface damage when removed.
- Do not place any dissolvable items such as plastic, aluminum foil or cellophane on the ceramic glass surface area of the cooktop. Once these products are melted in the cooktop, they must be removed with scrapers immediately.

NOTE

Please be advised that the Samsung warranty does NOT cover service calls to explain product operation, correct improper installation, or perform normal cleaning or maintenance.

Cleaning and maintaining the hood

WARNING

Fatty deposits in the grease filter may catch fire and there is a risk of fire.

NOTE

- The sensor response may vary depending on the usage environment (near construction sites, along roadsides, when using a vacuum cleaner, during bedding/clothing arrangement, near fabric sofas, etc.).
- The sensor response may temporarily increase in the following cases: – When used in places with furry carpets, animal hospitals with shedding animals, clothing stores, humid areas, places with smoke, or areas with many insects. – When using humidifiers, electric rice cookers, sprays, or misting devices. – When used in environments with yellow dust or external air inflow (such as building ventilation systems, apartment ventilation systems, or near windows with drafts).
- In environments affected by electromagnetic waves or electrical noise, the sensor response may be increased.
- To maintain the hood performance, you must frequently clean the accessories (Tray filter, Grease filter, Grille).
- The degree of contamination varies depending on the usage environment, so cleaning should be carried out as needed based on the contamination status (every 2 or 3 weeks).
- Charcoal filters cannot be washed and can only be replaced.

Cleaning the hood

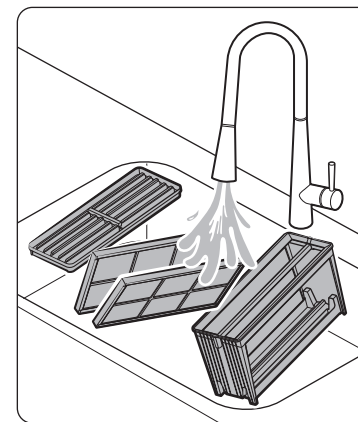
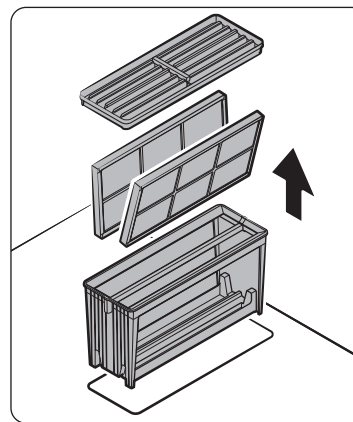

1. Lift the Grille and detach the Tray Filter.
2. Disassemble the Grease Filter.
3. Please use a soft sponge or brush soaked in warm water and neutral liquid detergent to wipe away and remove grease stains from the inside of the hood and its parts.
4. Once cleaning is complete, reassemble the parts in reverse order of disassembly.

WARNING

- Be sure to turn off the power when cleaning the hood.
- Do not use tools or equipment such as steel wool.
- Do not use baking soda, hydrogen peroxide, citric acid, abrasives, alcohol, etc. This may damage the coating or cause discoloration.
- Always wear gloves for safety during cleaning.
- Do not spray water directly on the hood while it is installed. There is a risk of electric shock and fire.
- Finger and greasy marks easily appear on the surface, but are not as visible as on a reflective glass surface.

Cleaning the Hood (Dishwasher)

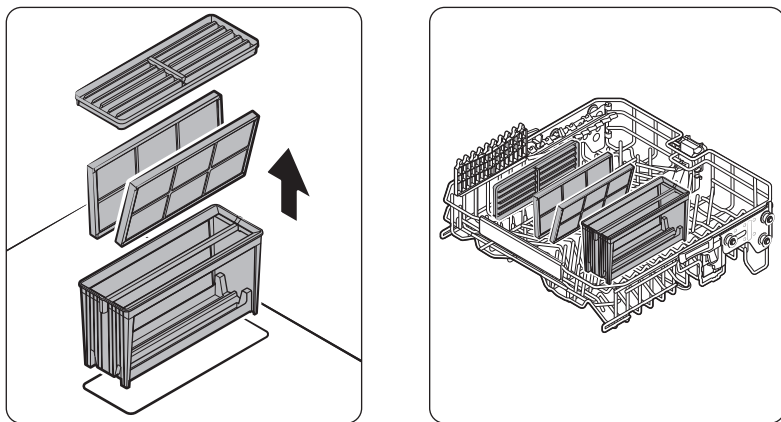

1. Lift the Grille and detach the Tray Filter.
2. Disassemble the Grease Filter.
3. Place the Grille and Tray Filter and Grease Filter in the dishwasher. But do not stack them.
4. Use a general household dishwasher detergent and clean at a low temperature with a short cycle.
5. Once cleaning is complete, reassemble the parts in reverse order of disassembly.

⚠ WARNING

- The filter may discolor during washing, but this does not affect its performance.
- Do not wash heavily greased grease filters together with tableware.
- The edges of the filter are sharp and can cause injury, so always wear gloves when handling it.
- Finger and greasy marks easily appear on the surface, but are not as visible as on a reflective glass surface.

Cleaning the Hood Cover

If water or food particles have entered the Hood, clean it using this method.

⚠ WARNING

- Ensure the product's power is turned off before cleaning.
- There is a risk of electric shock.

📖 NOTE

If the cabinet is fixed at the bottom, there must be enough space for the hood cover to be disassembled.

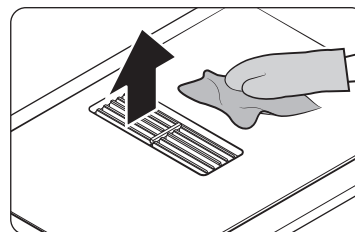

1. Carefully wipe around the grille with a dry towel. Carefully lift and detach the grille, tray filter, and grease filter.

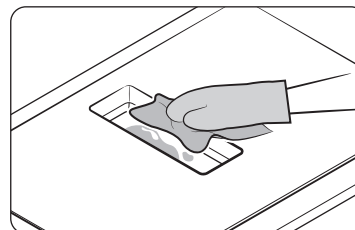

2. Wipe the water and food(oil) that has entered inside the product.

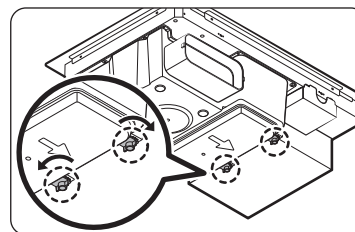

3. Please rotate the two holders in opposite direction.

⚠ CAUTION

Please be careful not to spill water when separating the hood cover.

Cleaning and Maintenance

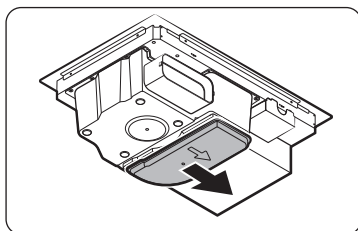

4. Push the hood cover in the direction of the arrow.

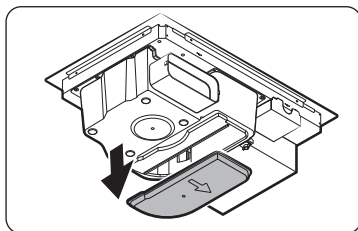

5. Detach the cover from the hood basket in a downward direction, and when washing is complete, assemble the cover in the reverse order.

NOTE

Recommend removing the hood cover to clean hardened oil.
After separation, please wipe off water and food(oil) with a dry towel before washing.

CAUTION

- If a lot of water has entered the hood top suction inlet, first remove and clean the tray filter. If the tray filter is overflowing, remove the water from the bottom of the tray filter first, then remove and clean the under tank.
- Cleaning the cover will be difficult if there is a shelf fixed to the bottom of the product inside the cabinet. In this case, remove the drawer before cleaning.

Replacing the Grease Filter

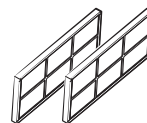

- This is a function that captures steam and oil fumes during cooking.
- To maintain the hood performance, you must frequently clean the grease filter.

WARNING

- Grease filter is made of metal, so it may be detected and heat up when placed on the induction cooktop.
- Do not place the grease filter on the Induction Cooktop.
- Always attach the grease filter to the product when in use.

WARNING

- If you use the product without attaching the grease filter, oil fumes during cooking can directly enter the inside of the product and the fan motor.
- Be sure to use the product with the grease filter correctly installed.

CAUTION

This part requires separate purchase and replacement through Samsung Service Center and Homepage(www.samsung.com/**/support) when needed.

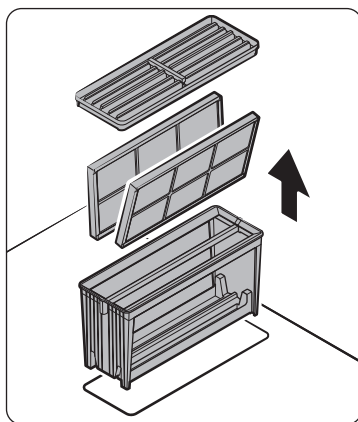

1. Lift the Grille and detach the Tray Filter.
2. Disassemble the Grease Filter.

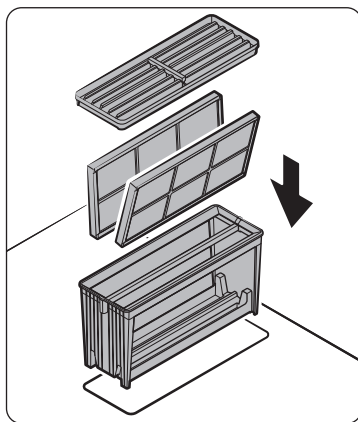

3. Replace with a new Grease Filter and reassemble in the reverse order of disassembly.

Replacing the Charcoal Filter

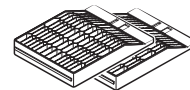

- This is a function that reduces smells from air drawn in during recirculation installation.
- The Charcoal filter has a standard lifespan of 360 hours, but its lifespan may vary depending on the cooking environment and usage patterns. It is recommended to replace it at least every 6 months.

⚠ CAUTION

This part cannot be cleaned and requires separate purchase and replacement through Samsung Service Center and Homepage(www.samsung.com/**/support) when needed.

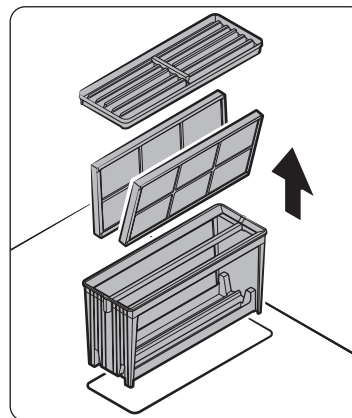

1. Lift the Grille and detach the Tray Filter.

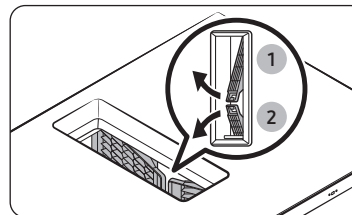

2. Pull the top part of the Charcoal Filter diagonally and then remove it.

Cleaning and Maintenance

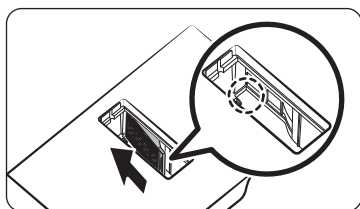

3. Assemble the new charcoal filter according to the inside guide marks.

NOTE

- Assemble with the flat surface facing up.
- Assemble the remaining filters in the opposite direction using the same method.

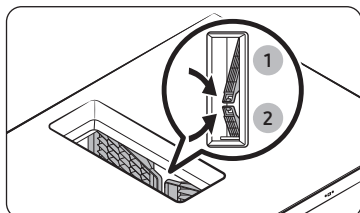

4. Insert the new charcoal filter at an angle.

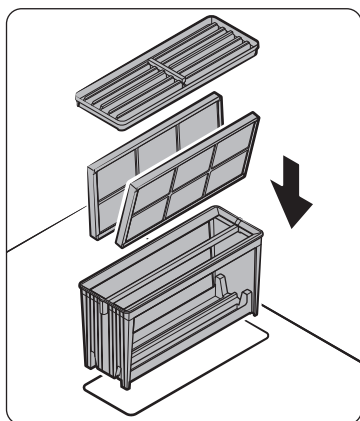

5. Assemble the remaining parts in reverse order of disassembly.

Troubleshooting and service

Troubleshooting

A fault may result from a minor information that you can correct yourself with the help of the following instructions. Do not attempt any further repairs if the following instructions do not help in each specific case.



WARNING

Repairs to the appliance are to be performed only by a qualified service technician. Improperly performed repairs may result in considerable risk to the user. If your appliance needs repair, please contact your customer service centre.





Problem	Possible cause	Solution
What should I do if the cooking zones are not functioning?	<ul style="list-style-type: none"> • The fuse in the house wiring is not intact. 	<ul style="list-style-type: none"> • If the fuses trip a number of times, call an authorised electrician.
What should I do if the cooking zones will not switch on?	<ul style="list-style-type: none"> • The Power button was accidentally pressed. • The control panel is partially covered by a damp cloth or liquid. 	<ul style="list-style-type: none"> • Ensure the appliance is properly switched on. • Clean the control panel.
What should I do if the display except for H, the residual heat indicator suddenly disappears?	<ul style="list-style-type: none"> • The Power button was accidentally actuated. • The control panel is partially covered by a damp cloth or liquid. 	<ul style="list-style-type: none"> • The appliance is properly switched on. • Clean the control panel.
What should I do if, after the cooking zones have been switched off, residual heat is not indicated in the display	<ul style="list-style-type: none"> • The cooking zone was only briefly used and therefore did not become hot enough. 	<ul style="list-style-type: none"> • If the cooking zone is hot, please call a local service centre.



Problem	Possible cause	Solution
The hood's mode changes automatically.	<ul style="list-style-type: none"> Is it operating in Smart/Auto mode? Is it operating in Boost mode? 	<ul style="list-style-type: none"> The Smart/Auto mode operates automatically according to sensor and cooking zone power. <ul style="list-style-type: none"> Sensor and cooking zone power (CC90H84JAD): Smart Cooking zone power (CC90H84PAD): Auto The Boost mode operates for a maximum of 8 minutes, and then switches to 9 level operation.
The hood's wind strength is weak.	<ul style="list-style-type: none"> Is there a lot of foreign matter in the filter? 	<ul style="list-style-type: none"> Wipe off the filter with a neutral detergent in lukewarm water.

Information codes

Information code	Possible cause	Solution
E0	There is a problem with the cooking zone temperature sensor.	Restart the appliance using the Power  key. If the problem continues, disconnect power for more than 30 seconds. Then, restart the appliance and try again. If the problem still continues, contact a local service centre.
E1	The temperature is sensed higher than specified. When an error occurs, the hood stops operating to prevent the spread of fire.	
E2	There is a problem with the PBA sensor.	
A4 , A6	The DC Motor fails to operate because of problems with the PCB or wiring, or electrical disturbance on the motor blade.	
d0	A key is being pressed for more than 8 seconds.	Check if the key is wet or is being pressed. If the problem continues, restart the appliance using the Power  key. If the problem still continues, contact a local service centre.
F8 , FA	Communications between main and sub PCBs fail.	Restart the appliance using the Power  key. If the problem continues, disconnect power for more than 30 seconds. Then, restart the appliance. If the problem still continues, contact a local service centre.
F1	EEPROM Error occurs when EEPROM or Read is not performed.	
F2	The touch-enabled IC communicates abnormally.	

Troubleshooting and service

Information code	Possible cause	Solution
	It is out of normal voltage (220 ~ 240 V).	Check home power environment.
	If the cooking container is not suitable for the induction, or operates without the cooking container, it is displayed.	Use a cooking container suitable for inductions.
	Communications between main and Hood Main PCB.	It occurs when the Main PCB and Hood Main PCB are not communicating. Disconnect the power plug for more than 30 seconds, then allow the product to cool sufficiently before restarting. If this issue persists, please contact Samsung Electronics Service Center.
	EEPROM data information.	It occurs when the EEPROM data at Hood is interrupted, due to some noise, defects of Main PCB. Disconnect the power plug for more than 30 seconds, then allow the product to cool sufficiently before restarting. If this issue persists, please contact Samsung Electronics Service Center.

Information code	Possible cause	Solution
	Communications between Hood main and Hood Inverter PCB.	It occurs when the Hood Main PCB and Hood Inverter PCB are not communicating. Disconnect the power plug for more than 30 seconds, then allow the product to cool sufficiently before restarting. If this issue persists, please contact Samsung Electronics Service Center.
	FAN overcurrent error.	It occurs when a problem occurs in the electrical circuit that controls the hood fan's rotation and operation. Disconnect the power plug for more than 30 seconds, then allow the product to cool sufficiently before restarting. If this issue persists, please contact Samsung Electronics Service Center.
	FAN overload error.	It occurs when the hood fan is overloaded and overcurrent occurs. Disconnect the power plug for more than 30 seconds, then allow the product to cool sufficiently before restarting. If this issue persists, please contact Samsung Electronics Service Center.

Information code	Possible cause	Solution
H2	FAN Wire disconnection error.	It occurs when the hood fan is not receiving sufficient power or the fan wire is disconnected. If the issue persists, contact Samsung Electronics Service Center.
H3	The hood fan Over voltage / Low Voltage.	It occurs when the voltage supplied to the hood fan motor is too low or too high, or when there is a problem with the voltage sensor. Disconnect the power plug for more than 30 seconds, then allow the product to cool sufficiently before restarting. If this issue persists, please contact Samsung Electronics Service Center.
H4	The hood fan motor IPM temperature sensor.	It occurs when there is a problem with the temperature sensor that measures the surface temperature of the heat sink, which dissipates heat from the electrical circuit that controls the hood fan. Disconnect the power plug for more than 30 seconds, then allow the product to cool sufficiently before restarting. If this issue persists, please contact Samsung Electronics Service Center.

Information code	Possible cause	Solution
H5	The hood fan motor IPM overheat.	It occurs when a high temperature is detected in the internal electrical circuit that operates the hood fan. Disconnect the power plug for more than 30 seconds, then allow the product to cool sufficiently before restarting. If this issue persists, please contact Samsung Electronics Service Center.
H6	The hood fan motor output current sensor.	It occurs when there is a problem with the sensor that measures the current when the hood fan is operating. Disconnect the power plug for more than 30 seconds, then allow the product to cool sufficiently before restarting. If this issue persists, please contact Samsung Electronics Service Center.

Troubleshooting and service

Information code	Possible cause	Solution
H7	The hood fan motor DC voltage sensor.	It occurs when there is a problem with the sensor that measures the voltage in the electrical circuit that controls the hood fan. Disconnect the power plug for more than 30 seconds, then allow the product to cool sufficiently before restarting. If this issue persists, please contact Samsung Electronics Service Center.
H8	The hood fan motor not starting.	It occurs when the hood fan fails to operate. Disconnect the power plug for more than 30 seconds, then allow the product to cool sufficiently before restarting. If this issue persists, please contact Samsung Electronics Service Center.

What should I do if the cooking zone will not switch on or off?

This could be due to one of the following possibilities:

- The control panel is partially covered by a damp cloth or liquid.
- The child safety lock is on, and display .

What should I do if the display is illuminated?

Check for the following:

- The control panel is partially covered by a damp cloth or liquid. To reset, press the **Power**  key.
- If liquid has overflowed on control panel, please wipe the liquid.

What should I do if the display is illuminated?

Check for the following:

- The hob is overheated because of abnormal operation.
- After hob is cooled down, press the **Power**  key for resetting.

What should I do if the display is illuminated?

Check for the following:

- Cookware is unsuitable, too small, or no cookware has been placed on the cooking zone.
- If you use suitable cookware, displayed message will automatically disappear.

What should I do if the cooling fan runs after the hob is turned off?

Check for the following:

- When you have finished using the hob, the cooling fan runs by itself for cooling down.
- After the hob's electronics has cooled down or elapsed max time (10 minutes) the cooling fan will be turned off.
- If you request a service call because of an information made in operating the appliance, the visit from the customer service technician may incur a charge even during the warranty period.

Service

Before calling for assistance or service, please check the section "Troubleshooting". If you still need help, follow the instructions below.

Is it a technical fault?

If so, please contact your customer service centre.

Always prepare in advance for the discussion. This will ease the process of diagnosing the problem and also make it easier to decide if a customer service visit is necessary.

Please take note of the following information.

- What form does the problem take?
- Under what circumstances does the problem occur?

When calling, please know the model and serial number of your appliance. This information is provided on the rating plate as follows:

- Model description
- S/N code (15 digits)

We recommend that you record the information here for easy reference.

- Model:
- Serial number:

When do you incur costs even during the warranty period?

- If you could have remedied the problem yourself by applying one of the solutions provided in the section "Troubleshooting".
- If the customer service technician has to make several service calls because he was not provided with all of the relevant information before his visit and as a result, for example, has to make additional trips for parts. Preparing for your phone call as described above will save you the cost of these trips.

Technical specifications

Product Fiche compliant to commission delegated regulation (EU) No 65/2014

	Value	Unit
Supplier's name or trade mark	Samsung	-
Model identifier	CC90H84JAD / CC90H84PAD	-
Annual Energy Consumption - AEC _{hood}	44.1	kWh/a
Energy Efficiency Class	A+	-
Fluid Dynamic Efficiency - FDE _{hood}	32.0	-
Fluid Dynamic Efficiency Class	A	-
Light Efficiency - LE _{hood}	*	lux/W
Lighting Efficiency Class	*	-
Grease Filtering Efficiency - GFE _{hood}	95.1	%
Grease Filtering Efficiency Class	A	-
Minimum Air Flow in normal use	190.0	m ³ /h
Maximum Air Flow in normal use	600.0	m ³ /h
Air Flow at intensive/boost setting	720.0	m ³ /h
A-weighted Sound Power Emission at minimum speed	42	dB(A) re 1pW
A-weighted Sound Power Emission at maximum speed	68	dB(A) re 1pW
A-weighted Sound Power Emission at intensive or boost speed	72	dB(A) re 1pW
A-weighted Sound Power Emission at minimum speed - Recirculation mode **	41	dB(A) re 1pW
A-weighted Sound Power Emission at maximum speed - Recirculation mode **	70	dB(A) re 1pW
A-weighted Sound Power Emission at intensive or boost speed - Recirculation mode **	72	dB(A) re 1pW
Power consumption off mode - P _o	0.30	W
Power consumption in standby mode - P _s	*	W

Technical specifications

Additional Product Information compliant to commission regulation (EU) No 66/2014

	Symbol	Value	Unit
Time increase factor	f	0.8	-
Energy Efficiency Index	EE _{hood}	44.8	-
Measured air flow rate at best efficiency point	Q _{BEP}	381.0	m ³ /h
Measured air pressure at best efficiency point	P _{BEP}	456	Pa
Maximum air flow	Q _{max}	720.0	m ³ /h
Measured electric power input at best efficiency point	W _{BEP}	151.0	W
Nominal power of the lighting system	W _L	*	W
Average illumination of the lighting system on the cooking surface	E _{middle}	*	lux

* Does not apply to this product

** Voluntary declaration

Product Fiche compliant to commission delegated regulation (EU) No 65/2014

Data determined according to standard EN 61591, EN 60704-2-13, EN 50564, Commission Regulations (EU) No 65/2014 and (EU) No 66/2014.

Suggestions for a correct use in order to reduce the environmental impact: Switch ON the hood at minimum speed when you start cooking and keep it running for a few minutes after cooking is finished. Increase the speed only in case of large amount of smoke and vapor and use boost speed(s) only in extreme situations. Replace the charcoal filter(s) when necessary to maintain a good smell reduction efficiency. Clean the grease filter(s) when necessary to maintain a good grease filter efficiency. Use the maximum diameter of the ducting system indicated in this manual to optimize efficiency and minimize noise.

Technical data

Model identification		CC90H84JAD	CC90H84PAD
Appliance dimensions	Width	800 mm	800 mm
	Depth	520 mm	520 mm
	Height	230 mm	230 mm
Worktop cut - out dimensions	Width	882 mm	800 mm
	Depth	602 mm	602 mm
	Height	312 mm	312 mm
Connection voltage		220 ~ 230V / 50 ~ 60 Hz	220 ~ 230V / 50 ~ 60 Hz
Maximum connected load power		7.4 kW	7.4 kW
Weight	Net	29.9 kg	
	Gross	32.0 kg	

Cooking zones

Position	CC90H84JAD		CC90H84PAD	
	Power	Boost Time	Power	Boost Time
Left Front	2100 W / Boost 2700 W	8 min	1800 W / Boost 2600 W	8 min
Left Rear	2100 W / Boost 2700 W	8 min	1800 W / Boost 2600 W	8 min
Right Front	2100 W / Boost 2700 W	8 min	2200 W / Boost 3400 W	8 min
Right Rear	2100 W / Boost 2700 W	8 min	1500 W / Boost 2600 W	8 min
Flex Zone	2100 W / Boost 2700 W	5 min	2400 W / Boost 3700 W	5 min
Complete Flex	2700 W / Boost 3700 W	5 min	-	-

Appendix

Product information

Supplier's name	Samsung Electronics co. Ltd.	Samsung Electronics co. Ltd.
Model identification	CC90H84JAD	CC90H84PAD
Number of cooking zones and/or area	2	3
Energy consumption per cooking zone or area calculated per kg (EC _{electric cooking})	36.5 x 21.0 cm : 190 Wh/kg 36.5 x 21.0 cm : 190.9 Wh/kg	36.5 x 18.0 cm : 196.5 Wh/kg (Left) 18.0 cm : 185.5 Wh/kg (Upper) 21.0 cm : 178.6 Wh/kg (Lower)
Energy consumption for the hob calculated per kg (EC _{electric hob})	190.5 Wh/kg	186.8 Wh/kg

Data determined according to standard EN 60350-2 and Commission Regulations (EU) No 66/2014.

Overall Standby Power consumption (W) (All network ports is "on" condition)		1.9 W
Period of time for the power management (min)		20 min.
Wi-Fi	Standby-mode Power Consumption (W)	1.9 W
	Period of time for the power management (min)	20 min.
Off mode	Power consumption	0.30 W
	Period of time for the power management (min)	20 min.

Energy Saving Tips

Save energy by:



- Positioning pots and pans before switching on the zone.
- Keeping zones and pan bases clean.
- Using lids firmly on pots and pans.
- Switching zones off before the end of cooking time and using residual heat.

NOTE

Hereby, Samsung declares that this radio equipment is in compliance with Directive 2014/53/EU and with the relevant statutory requirements in the UK. The full text of the EU declaration of conformity and the UK declaration of conformity is available at the following internet address: The official Declaration of conformity may be found at <http://www.samsung.com.go.to/Support> > Search Product Support and enter the model name.

	Frequency range	Transmitter power (Max)
Wi-Fi	2412-2472 MHz	20 dBm
Bluetooth	2402-2480 MHz	10 dBm

QUESTIONS OR COMMENTS?

COUNTRY	CONTACT CENTER	WEB SITE
UK	0333 000 0333	www.samsung.com/support
IRELAND (EIRE)	0818 717100	
GERMANY	06196 77 555 77	
FRANCE	01 48 63 00 00	
SPAIN	91 175 00 15	
PORTUGAL	210 608 098 Chamada para a rede fixa nacional Dias úteis das 9h às 20h	
LUXEMBURG	+352 2610 3710	
NETHERLANDS	+31 88 909 0111	
BELGIUM	+32 26200210	
NORWAY	21 62 90 99	
DENMARK	70 70 19 70	
FINLAND	OLD 030-622 75 15, NEW number: 0800 528 475	
SWEDEN	0771-400 300	
AUSTRIA	0800 72 67 864 (0800-SAMSUNG)	
SWITZERLAND	0800 726 786	
HUNGARY	061 42 92 312 	
CZECH	800726786 	
SLOVAKIA	800726786 	
CROATIA	072 726 786	

COUNTRY	CONTACT CENTER	WEB SITE
BOSNIA	055 233 999	www.samsung.com/support
North Macedonia	023 207 777	
MONTENEGRO	020 405 888	
SLOVENIA	080 697 267 (brezplačna številka)	
SERBIA	011 321 6899	
Kosovo	038 40 30 90	
ALBANIA	045 620 202	
BULGARIA	0800111 31-Безплатен за всички оператори *3000-Цена на един градски разговор или според тарифата на мобилният оператор 09:00 до 18:00-Понеделник до Петък	
ROMANIA	0800872678-Apel gratuit *8000-Apel tarifat în rețea Program Call Center Luni - Vineri: 9 AM - 6 PM	
ITALIA	800-SAMSUNG (800.7267864)	
CYPRUS	8009 4000 only from landline, toll free	
GREECE	80111-SAMSUNG (80111 726 7864) from mobile and land line (+30) 210 6897691 from mobile and land line	
POLAND	801-172-678* * (opłata według taryfy operatora)	
LITHUANIA	0-800-77777	
LATVIA	8000-7267	
ESTONIA	800-7267	
UKRAINE	0-800-502-000	
MOLDOVA	+373-22-667-400	